



Installation Instructions

Standard Beam Installation

General & Safety Information

- Wear proper personal protective equipment (PPE).
- Operate all tools per manufacturer guidelines.
- Standard woodworking saws and blades can be used for cutting Fypon® polyurethane (PUR) products.
- Fypon PUR parts are NOT load bearing.
- Always follow applicable code requirements and clearances with other equipment or fixtures per manufacturer recommendations.
- For truss applications, refer to Fypon Beam Truss Installation Instructions, which can be found at [fypon.com/install](https://www.fypon.com/install).
- For best results, finish and allow to dry prior to installation. Refer to Fypon General Finishing Instructions, which can be found at [fypon.com/install](https://www.fypon.com/install).
- All Fypon products must be installed per the following instructions and finished within 90 days of installation to maintain warranty coverage.

Tools / Materials

- Pencil
- Tape Measure
- Level
- Square and / or T-bevel
- Stud finder
- Painter's tape
- Hammer or pneumatic nailer
- Nail countersink
- Drill / driver (if using screws)
- Putty knife
- Saw (if trimming)
- 2x lumber (for blocking)
- Sandpaper (220-grit recommended)
- Chalk line
- Caulk gun
- Exterior-grade polyurethane-compatible sealant and /or filler
- Exterior-grade polyurethane-compatible adhesive (Loctite® PL Premium® recommended)
- Exterior-grade fasteners (trim-head screws recommended)

Installation Instructions

1) Mark installation area.

Mark the desired location(s) for the beam (Figure 1).
A chalk line works well for this.

Figure 1

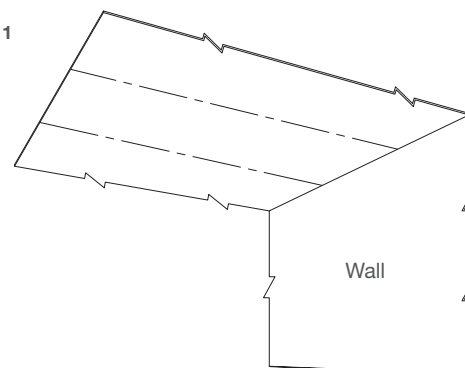

2) Mark mounting locations.

If studs / rafters are present, use a stud finder to identify and mark locations for the mounting blocks on studs or rafters. If studs / rafters are not present, toggle bolts should be used. Mounting block locations should be within 3" of the ends of the beam, 16" – 24" apart, and at any joints where beams meet (Figure 2).

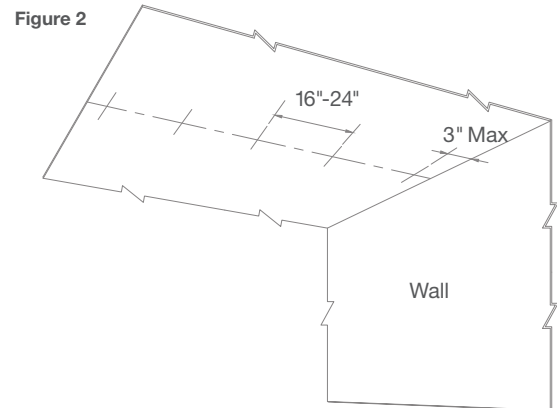

3) Fabricate mounting blocks.

Measure the inside width of the beam and cut blocks to fit inside the beam (Figure 3A).

For suspended beams 8' long and shorter, the inside of the beam can be used to trace the outline for a mounting block that can be fastened to the wall (Figure 3B).

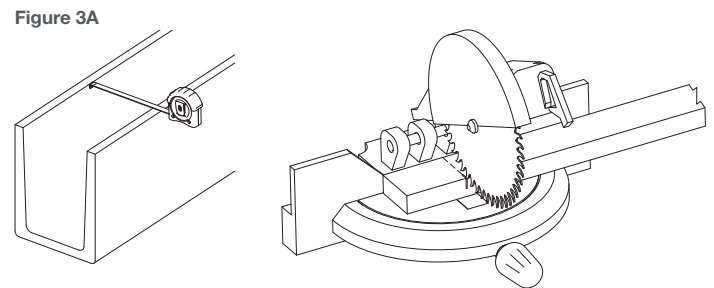

For suspended beams over 8' long, a board or boards should extend the full length of the beam to prevent the beam from sagging over time. Multiple boards may need to be screwed together with mounting blocks attached to both sides to fasten the beam to (Figure 3C). Mounting block locations should be within 3" of the ends of the beam, 16" – 24" apart, and at any joints where beams will meet.

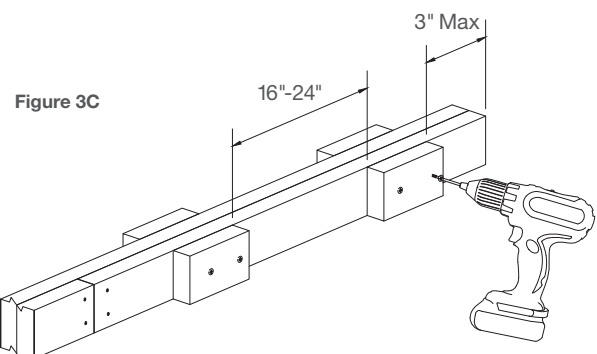
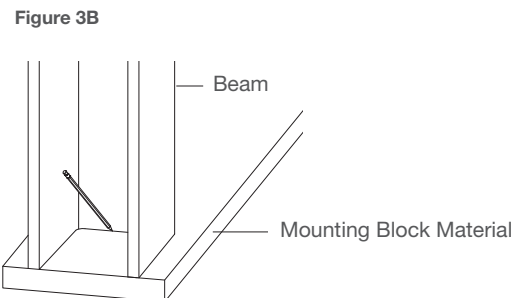

4) Install mounting blocks.

Align and fasten mounting blocks with the marks made in the previous step. Mark the block locations with painter's tape that will be visible and removable after the beam is installed (Figure 4A). If screwing into studs / rafters, make sure the screw will penetrate at least 1" into the stud / rafter (Figure 4B). If not screwing into studs / rafters, use toggle bolts (Figure 4C). Use at least two fasteners per mounting block.

Figure 4A

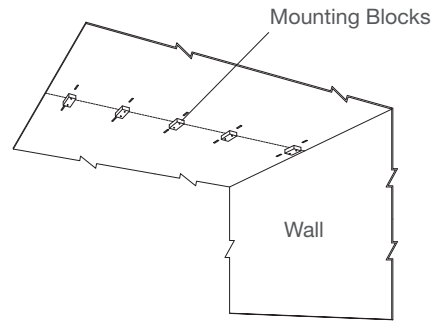

If installing a ridge beam along the peak of a vaulted ceiling, install additional mounting blocks stacked on the first ones to provide sufficient contact surface for the beam (Figure 4D).

Figure 4B

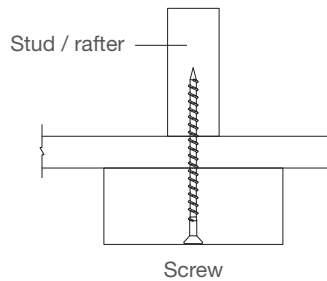
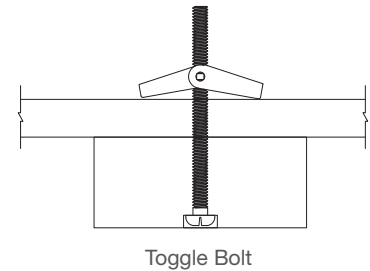

Figure 4C



If installing a suspended beam, install mounting blocks to the walls or joist hangers and full-length board (Figure 4E).

5) Cut beam and machine as needed.

Refer to Fypon® Beam Fabrication Instructions if this was not already done.

Figure 4D

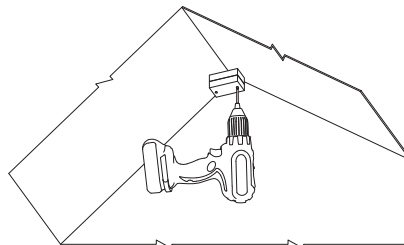
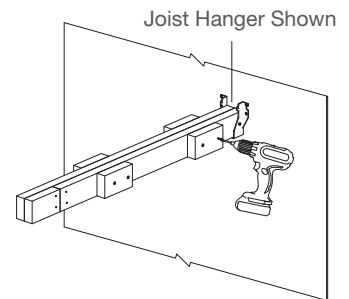

Figure 4E



6) Dry fit the beam.

Once beam has acclimated to the installation temperature for at least 24 hours, position the beam where it will be installed (Figure 6) and confirm a tight fit. If not, trim as needed.

Figure 6

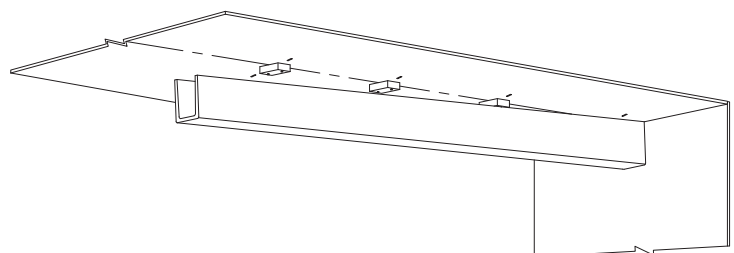

7) Apply adhesive.

Apply a 1/4" bead of adhesive to the sides of the mounting blocks that will contact the beam (Figure 7).

Figure 7

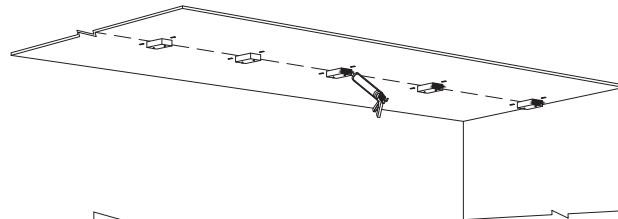

8) Fasten the beam.

Position the beam in place over the mounting blocks and up against the ceiling (if applicable). Fasten to the mounting blocks from the side of the beam, with at least four fasteners per mounting block (two per side), making sure to countersink them below the surface (Figure 8). Any painter's tape on the ceiling can also be removed after the beam is installed.

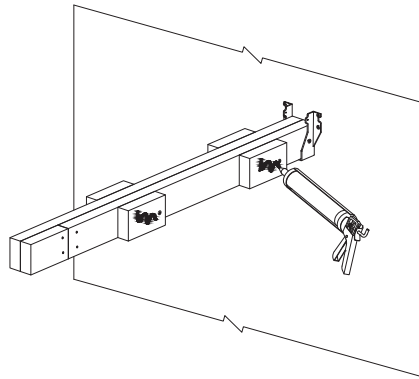

9) Fill and sand fastener holes.

Fill fastener holes with filler and sand to match surrounding area, if needed, but be careful not to remove the primer.

Figure 8

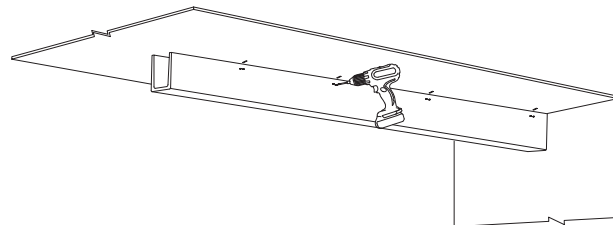

10) Touch up or finish.

Refer to Fypon® General Finishing Instructions. If part was finished prior to installation, touch up filled fastener holes with color-matched finish. Joints and seams can also be caulked if desired.

